

City&Harbor Train Set















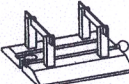

Track Layout Guide

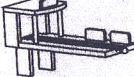

by maxim
enterprise, inc.

Contents 50023

Please make sure to count all components before assembling the product.

- A.  4.25" Straight Track x1PC
- B.  6" Straight Track x4PCS
- C.  8.25" Straight Track x1PC
- D.  Curved Track x5PCS
- E.  Short Curved Track x9PCS
- F.  Ascending Track x2PC
- G.  Crossing Barrier x1PC
- H.  x2PCS
- I.  Support Block x3PCS
- J.  Suspension Bridge x1pc
- K.  x1pc
- M.  x1pc
- N.  x1pc
- O.  x1pc
- P.  x1pc
- R.  x1pc

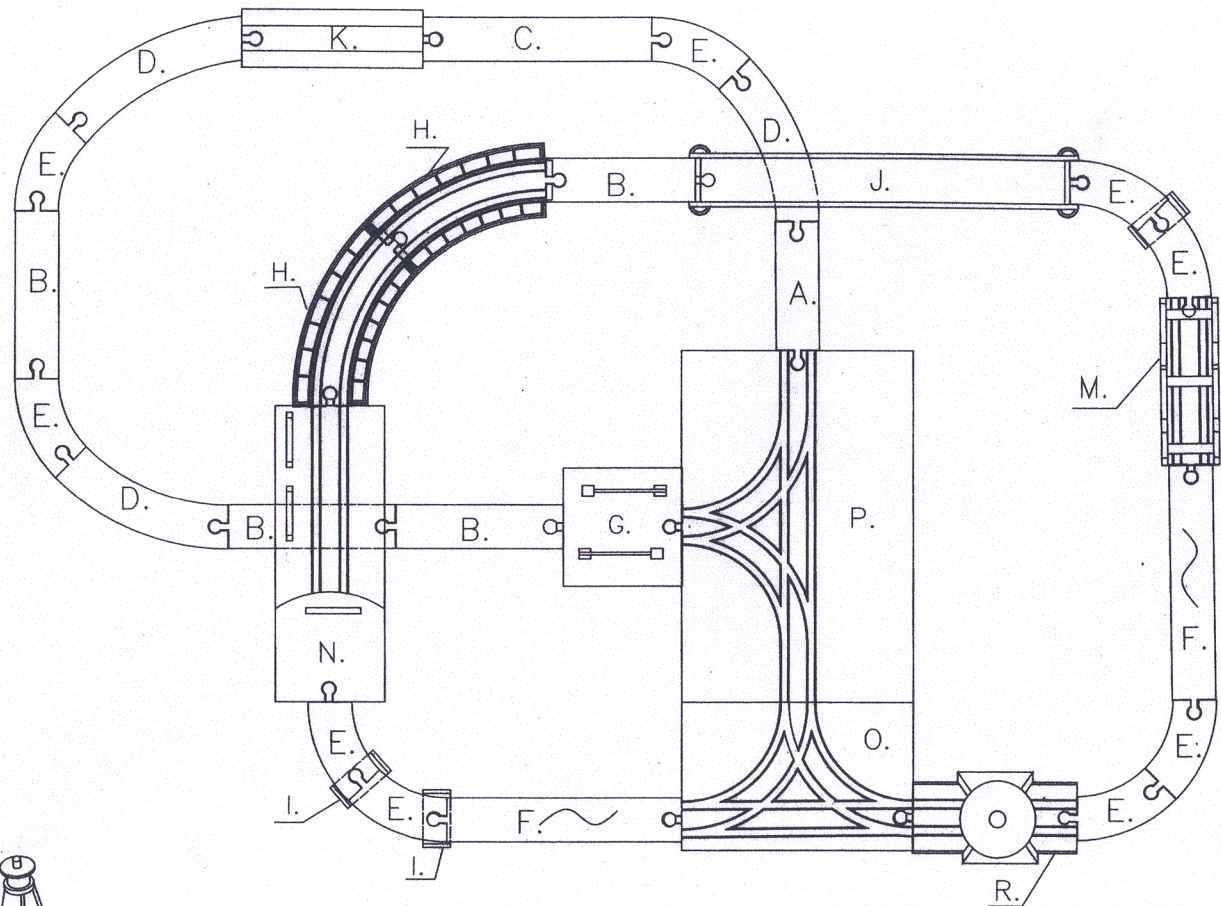

WARNING:
CHOKING HAZARD - Small parts.
Not for children under 3 years.

(C) 2013 Maxim Enterprise, Inc. For customer service information please contact us toll free at: 1-888-26-MAXIM(266-2946) or visit our website at: www.maximenterprise.com

Made in China